

BeneHeart C & BeneHeart S Series

Automatic External Defibrillator

Operator's Manual

(BeneHeart C1/BeneHeart C1A/BeneHeart C2/BeneHeart C2A/
BeneHeart C1 Fully Automatic/BeneHeart C1A Fully Automatic/
BeneHeart C2 Fully Automatic/BeneHeart C2A Fully Automatic/
BeneHeart S1/BeneHeart S1A/BeneHeart S2/BeneHeartS2A/
BeneHeart S1 Fully Automatic/BeneHeart S1A Fully Automatic/
BeneHeart S2 Fully Automatic/BeneHeart S2A Fully Automatic)



© Copyright 2019 Shenzhen Mindray Bio-Medical Electronics Co., Ltd. All rights reserved.

- Release time: July 2019
- Revision: 2.0

Intellectual Property Statement

SHENZHEN MINDRAY BIO-MEDICAL ELECTRONICS CO., LTD. (hereinafter called Mindray) owns the intellectual property rights to this Mindray product and this manual. This manual may refer to information protected by copyright or patents and does not convey any license under the patent rights or copyright of Mindray, or of others.

Mindray intends to maintain the contents of this manual as confidential information. Disclosure of the information in this manual in any manner whatsoever without the written permission of Mindray is strictly forbidden.

Release, amendment, reproduction, distribution, rental, adaptation, translation or any other derivative work of this manual in any manner whatsoever without the written permission of Mindray is strictly forbidden.

mindray and **BeneHeart** are the trademarks, registered or otherwise, of Mindray in China and other countries. All other trademarks that appear in this manual are used only for informational or editorial purposes. They are the property of their respective owners.

Responsibility on the Manufacturer Party

Contents of this manual are subject to change without prior notice.

All information contained in this manual is believed to be correct. Mindray shall not be liable for errors contained herein or for incidental or consequential damages in connection with the furnishing, performance, or use of this manual.

Mindray is responsible for the effects on safety, reliability and performance of this product, only if:

- all installation operations, expansions, changes, modifications and repairs of this product are conducted by Mindray authorized personnel;
- the electrical installation of the relevant room complies with the applicable national and local requirements; and
- the product is used in accordance with the instructions for use.

WARNING

- **This equipment must be operated by persons who have been trained in its operation. The operator should be trained in basic life support, advanced cardiac life support or other emergency medical response.**
-

Warranty

THIS WARRANTY IS EXCLUSIVE AND IS IN LIEU OF ALL OTHER WARRANTIES, EXPRESSED OR IMPLIED, INCLUDING WARRANTIES OF MERCHANTABILITY OR FITNESS FOR ANY PARTICULAR PURPOSE.

Exemptions

Mindray's obligation or liability under this warranty does not include any transportation or other charges or liability for direct, indirect or consequential damages or delay resulting from the improper use or application of the product or the use of parts or accessories not approved by Mindray or repairs by people other than Mindray authorized personnel.

This warranty shall not extend to:

- Malfunction or damage caused by improper use or man-made failure.
- Malfunction or damage caused by force majeure such as fire and earthquake.
- Malfunction or damage caused by improper operation or repair by unqualified or unauthorized service people.
- Malfunction of the instrument or part whose serial number is not legible enough.
- Others not caused by instrument or part itself.

Company Contact

Manufacturer:	Shenzhen Mindray Bio-Medical Electronics Co., Ltd.
Address:	Mindray Building, Keji 12th Road South, High-tech industrial park, Nanshan, Shenzhen 518057, P.R.China
Website:	www.mindray.com
E-mail Address:	service@mindray.com.cn
Tel:	+86 755 81888998
Fax:	+86 755 26582680

EC-Representative:	Shanghai International Holding Corp. GmbH (Europe)
Address:	Eiffestraße 80, 20537 Hamburg, Germany
Tel:	0049-40-2513175
Fax:	0049-40-255726

Preface

Manual Purpose

This manual contains the instructions necessary to operate the product safely and in accordance with its function and intended use. Observance of this manual is a prerequisite for proper product performance and correct operation and ensures patient and operator safety.

This manual is based on the maximum configuration and therefore some contents may not apply to your product. If you have any question, please contact us.

Intended Audience

This manual is intended for persons who have been trained in equipment's operation. The operator should be trained in basic life support, advanced cardiac life support or other emergency medical response.

Illustrations

All illustrations in this manual serve as examples only. They may not necessarily reflect the setup or data displayed on your equipment.

Conventions

- ***Italic*** text is used in this manual to quote the referenced chapters or sections.
- `[]` is used to enclose screen texts.
- `→` is used to indicate operational procedures.

Contents

1 Safety	1 - 1
1.1 Safety Information	1 - 1
1.1.1 Dangers	1 - 1
1.1.2 Warnings	1 - 1
1.1.3 Cautions	1 - 2
1.1.4 Notes	1 - 2
1.2 Equipment Symbols	1 - 3
2 Equipment Introduction	2 - 1
2.1 Overview	2 - 1
2.2 Intended Use	2 - 2
2.3 Applied Parts	2 - 2
2.4 Main Unit	2 - 2
2.4.1 Top View	2 - 2
2.4.2 Bottom View	2 - 4
2.4.3 Back View	2 - 4
3 Getting Started	3 - 1
3.1 Preparation Safety Information	3 - 1
3.2 Equipment Installation	3 - 1
3.2.1 Unpacking and Checking	3 - 1
3.2.2 Environmental Requirements	3 - 2
3.2.3 Connecting the Electrode Pads	3 - 2
3.3 Turning on the Equipment	3 - 3
3.4 Switching Voice Language	3 - 3
3.5 Turning off the Equipment	3 - 3
4 Using the Equipment	4 - 1
4.1 Operating Safety Information	4 - 1
4.2 Screen Display (for Equipment Configured with the Screen)	4 - 2
4.3 Responds to a Rescue	4 - 3
4.4 Performing CPR	4 - 5
4.4.1 Using the CPR Metronome	4 - 5
4.4.2 Using the CPR Sensor	4 - 5
4.5 Preparation for Next Rescue	4 - 6
5 Data Management	5 - 1
5.1 Data Management Overview	5 - 1
5.2 Generating a Patient File	5 - 1
5.3 Managing Configurations	5 - 1
5.4 AED ALERT System Overview	5 - 2
5.5 Accessing the AED ALERT System	5 - 2
6 Battery	6 - 1
6.1 Battery Introduction	6 - 1

6.2 Battery Safety Information	6 - 1
6.3 Battery Indications	6 - 1
6.3.1 Battery Power Indicators (for Equipment Configured with the Screen)	6 - 1
6.3.2 Battery Prompts	6 - 2
6.4 Replacing the Battery	6 - 2
6.5 Storing Batteries	6 - 3
6.6 Recycling Batteries	6 - 3
7 Care and Cleaning	7 - 1
7.1 General Points	7 - 1
7.2 Cleaning	7 - 1
7.3 Disinfecting	7 - 2
7.4 Sterilization	7 - 2
8 Maintenance and Testing	8 - 1
8.1 Maintenance Introduction	8 - 1
8.2 Maintenance Safety Information	8 - 1
8.3 Performing Maintenance	8 - 2
8.3.1 User Test	8 - 2
8.3.2 Auto Test	8 - 3
8.3.3 Electrode Pads Check	8 - 3
8.4 Disposing the Equipment	8 - 3
9 Accessories	9 - 1
9.1 Therapy Accessories	9 - 1
9.2 Miscellaneous	9 - 2
A Specifications	A - 1
A.1 Safety Specifications	A - 1
A.2 Environmental Specifications	A - 1
A.3 Physical Specifications	A - 2
A.4 Display Specifications (for Equipment Configured with the Screen)	A - 2
A.5 Audio Indicators	A - 2
A.6 Interface Specifications	A - 3
A.7 Battery Specifications	A - 3
A.8 Data Storage	A - 4
A.9 Wireless Specifications	A - 5
A.10 Defibrillator Specifications	A - 5
A.11 ECG Specifications (for Equipment Configured with the Screen)	A - 7
A.12 Electrode Pads Specifications	A - 7
B Mindray Shockable Rhythm Analysis Algorithm	B - 1
B.1 Rhythm Recognition and Annotation Methodology	B - 1
B.1.1 Database for Evaluation of Mindray Algorithm Performance	B - 1
B.1.2 Rhythm Categories	B - 1
B.2 Mindray Shockable Rhythm Analysis Algorithm Performance	B - 2

C EMC and Radio Regulatory Compliance	C - 1
C.1 EMC	C - 1
C.2 Radio Regulatory Compliance	C - 4
D Default Settings	D - 1
D.1 General Setup	D - 1
D.2 AED Setup	D - 2
D.3 CPR Setup	D - 2
D.4 Test Setup	D - 3
D.5 WLAN Setup	D - 3
D.6 AED ALERT Related Setup	D - 4
E Voice Prompts	E - 1
F Symbols and Abbreviations	F - 1
F.1 Units	F - 1
F.2 Symbols	F - 2
F.3 Abbreviations and Acronyms	F - 2
G Inspection Record	G - 1
H Device Tracking	H - 1
I Declaration of Conformity	I - 1

This page intentionally left blank.

1 Safety

1.1 Safety Information

DANGER

- Indicates an imminent hazard that, if not avoided, will result in death or serious injury.
-
-

WARNING

- Indicates a potential hazard or unsafe practice that, if not avoided, could result in death or serious injury.
-
-

CAUTION

- Indicates a potential hazard or unsafe practice that, if not avoided, could result in minor personal injury or product/property damage.
-
-

NOTE

- Provides application tips or other useful information to ensure that you get the most from your product.
-
-

1.1.1 Dangers

DANGER

- The equipment delivers up to 360 J of electrical energy. Unless properly used by following the prompts provided by the equipment, this electrical energy may cause serious injury or death. Do not attempt to operate this equipment unless thoroughly familiar with the operations and functions of all controls, indicators, connectors, and accessories.
 - To avoid explosion hazard, do not use the equipment in the presence of oxygen-rich atmospheres, flammable anesthetics, or other flammable agents (such as gasoline). Keep the equipment and the operating environment dry and clean.
 - Defibrillation current can cause operator or bystander severe injury or even death. Keep distance with the patient or metal devices connected to the patient during defibrillation.
-
-

1.1.2 Warnings

WARNING

- Check for mechanical damages before each use. If case of any damage, do not apply it to patients.
 - Before putting the system into operation, the operator must verify that the equipment, connecting cables and accessories are in correct working order and operating condition.
 - The equipment is not intended to be used within the Magnetic Resonance (MR) environment.
 - Do not open the equipment housings. All servicing and future upgrades must be carried out by the service personnel.
 - This equipment is used for single patient at a time.
 - Do not open the equipment housings. All servicing and future upgrades must be carried out by the service personnel.
-
-

- **Medical electrical equipment which does not incorporate defibrillator protection should be disconnected during defibrillation.**
 - **Do not defibrillate a patient who lies on wet ground.**
 - **For the treatment of patients with implantable pacemakers, place the electrode pads away from internal pacemaker generator if possible to help prevent damage to the pacemaker.**
 - **To avoid inadvertent disconnection, route all cables in a way to prevent a stumbling hazard. Wrap and secure excess cabling to reduce risk of entanglement or strangulation by patients or personnel.**
 - **Do not touch device connectors or other live equipment if in contact with the patient; otherwise patient injury may result.**
 - **Do not touch the patient and live parts simultaneously. Otherwise patient injury may result.**
 - **Package material may contaminate the environment. Properly dispose of the package material according to applicable waste control regulations and keep it out of children's reach.**
 - **Keep a distance of at least 20cm away from the equipment when the wireless function is in use.**
-
-

1.1.3 Cautions

CAUTION



















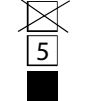



- **At the end of its service life, the equipment, as well as its accessories, must be disposed of in compliance with the guidelines regulating the disposal of such products to avoid contaminating the environment.**
 - **Magnetic and electrical fields are capable of interfering with the proper performance of the equipment. For this reason make sure that all external devices operated in the vicinity of the equipment comply with the relevant EMC requirements. Mobile phones, X-ray equipment or MRI devices are a possible source of interference as they may emit higher levels of electromagnetic radiation.**
 - **Always install or carry the equipment properly to avoid damage caused by drop, impact, strong vibration or other mechanical force.**
 - **Dry the equipment immediately in case of rain.**
-

1.1.4 Notes

NOTE

- **Put the equipment in a location where you can easily view and operate the equipment.**
 - **During normal use, the operator shall stand in a location where the equipment can be easily viewed and operated.**
 - **If the equipment has been dropped or mishandled, perform a user test. If any item fails, contact the authorized service personnel.**
-

1.2 Equipment Symbols

	Refer to instruction manual/ booklet		General warning sign
	Shock button		DEFIBRILLATION-PROOF TYPE BF APPLIED PART
	Manufacturer		Date of manufacture
IP55	Dust-protected Protected against water jets		Do not expose the battery to high heat or open flames. Do not incinerate the battery.
	Do not crush the battery.		Do not mutilate the battery or open the battery case.
	Maximum stacks		Temperature limitations
	Humidity limitations		Atmospheric pressure limitations
	Fragile		Keep dry
	Right side up		Serial number
	USB connector		Non-ionizing electromagnetic radiation
	AUTHORISED REPRESENTATIVE IN THE EUROPEAN COMMUNITY		General symbol for recovery/ recyclable
	The product bears CE mark indicating its conformity with the provisions of the Council Directive 93/42/EEC concerning medical devices and fulfils the essential requirements of Annex I of this directive.		
	The following definition of the WEEE label applies to EU member states only. This symbol indicates that this product should not be treated as household waste. By ensuring that this product is disposed of correctly, you will help prevent bringing potential negative consequences to the environment and human health. For more detailed information with regard to returning and recycling this product, please consult the distributor from whom you purchased it. * For system products, this label may be attached to the main unit only.		

This page intentionally left blank.

2 Equipment Introduction

2.1 Overview

The BeneHeart C & S series automatic external defibrillator is designed for treating life-threatening heart beat irregularities.

There are two types of product models provided: semi-automatic and fully automatic. Some of the series equipments are configured with the screen. Characteristics of the product models are detailed in the following table.

Model		Defibrillation mode	With the Shock button?	With the Screen?
BeneHeart C series	BeneHeart C1	semi automatic	Yes	No
	BeneHeart C1A			
	BeneHeart C2			Yes
	BeneHeart C2A			
	BeneHeart C1 Fully Automatic	fully automatic	No	No
	BeneHeart C1A Fully Automatic			
	BeneHeart C2 Fully Automatic			Yes
	BeneHeart C2A Fully Automatic			
BeneHeart S series	BeneHeart S1	semi automatic	Yes	No
	BeneHeart S1A			
	BeneHeart S2			Yes
	BeneHeart S2A			
	BeneHeart S1 Fully Automatic	fully automatic	No	No
	BeneHeart S1A Fully Automatic			
	BeneHeart S2 Fully Automatic			Yes
	BeneHeart S2A Fully Automatic			

After the electrode pads are applied to the patient's chest, the equipment analyzes the patient's heart rhythm.

- If a shockable rhythm is detected, the semi-automatic model requires the operator to deliver the shock, the fully automatic model delivers the shock without any intervention.
- If non-shockable rhythm is detected, the equipment enters CPR status by default.

Both types of models provide voice instructions that guide you through the entire defibrillation process. A flashing Shock button on the semi-automatic model is also presented to reinforce the voice prompts

The equipment also provides real-time CPR feedback, including the chest compression depth, rate and interruption time if it is connected with a CPR sensor.

2.2 Intended Use

The BeneHeart C & S series defibrillator, hereafter called the equipment, is intended to be used on adults and children in a sudden cardiac arrest. The patients must be:

- Unresponsive
- Not breathing or not breathing normally

The equipment also guides the operator throughout cardiopulmonary resuscitation (CPR) with voice and/or visual guidance.

The equipment is to be used in public places and facilities by persons who have been trained in its operation. The operator should be trained in basic life support, advanced cardiac life support or other emergency medical response.

2.3 Applied Parts

The applied parts of the equipment are:

- Electrode pads
- CPR sensor (if configured)

2.4 Main Unit

Based on the clinical application, the view that the equipment laid on the ground with lid opened is taken as the reference direction. The following views are defined by the reference direction.

2.4.1 Top View

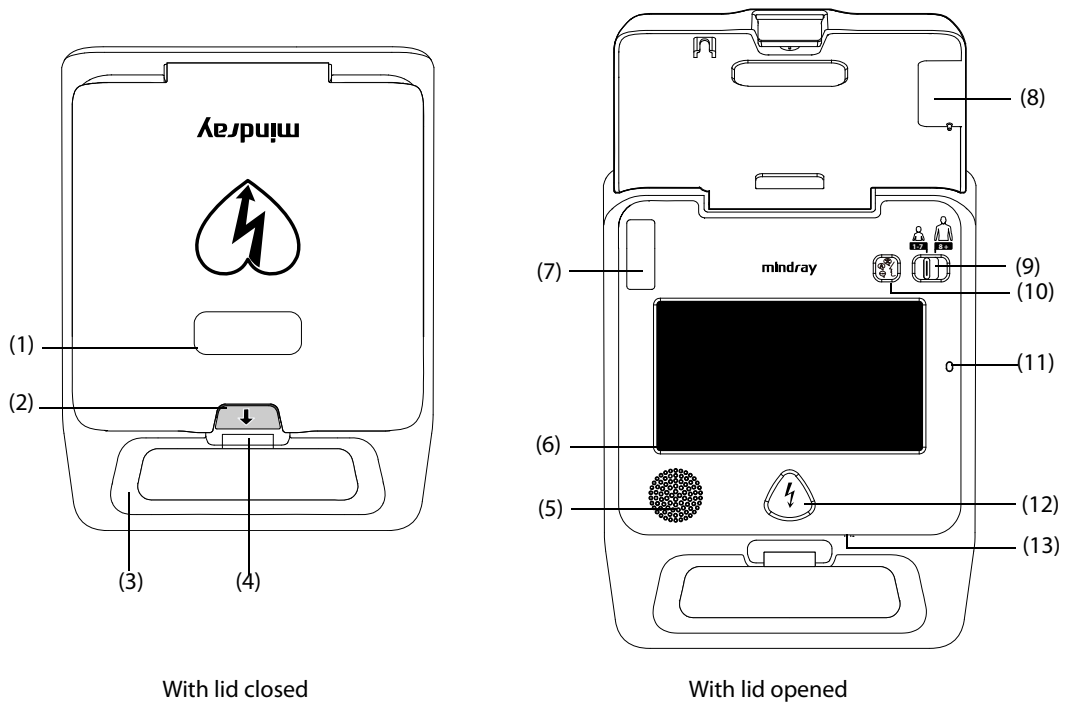

- (1) Pad expiration window: checks the expiration date of pads.
- (2) Latch: opens or closes the lid.
- (3) Handle
- (4) Status indicator
 - Green: the equipment is turned on, and can work correctly.
 - Flashing green: the equipment is in the standby status, and is ready for operation at any time.
 - Flashing red: auto test failure is detected on the equipment.
 - Off: no battery is installed or the battery is malfunctioning.
- (5) Speaker: the equipment automatically adjusts the volume depending on surrounding noise levels by default.
- (6) Display screen (for equipment configured with the screen)
- (7) Pads connector: connects the electrode pads.
- (8) Pads package holder: stores the electrode pads.
- (9) Adult/Child mode switch: flip right or left to switch between adult and child.
- (10) Language button: press to switch between the configured languages.
- (11) Optical sensor (for equipment configured with the screen): the equipment automatically adjusts the screen brightness depending on surrounding light by default.
- (12) Shock button (for semi-auto model): press to deliver a shock to the patient.
- (13) Microphone: records voices. It is available only when the record function is enabled.

2.4.2 Bottom View

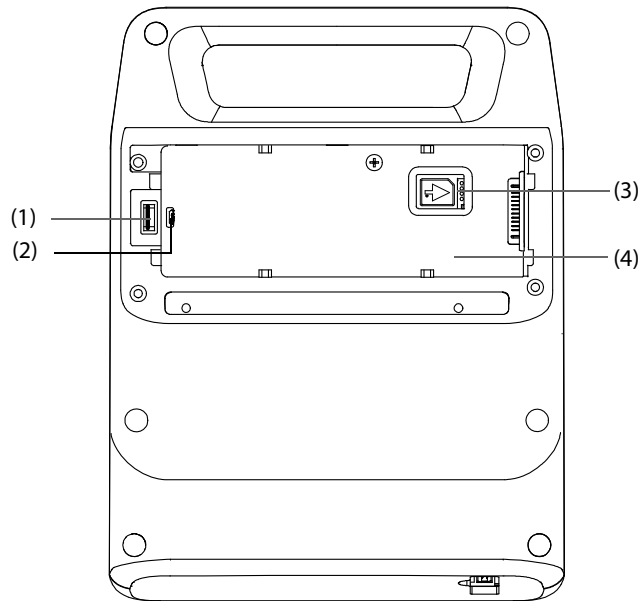

The battery compartment provides the following connectors.

- (1) USB connector: connects the USB flash memory.
- (2) micro USB connector: connects the computer.
- (3) Network connector (for equipment configured with the cellular module): connects the SIM card.
- (4) Battery compartment: stores the battery.

2.4.3 Back View

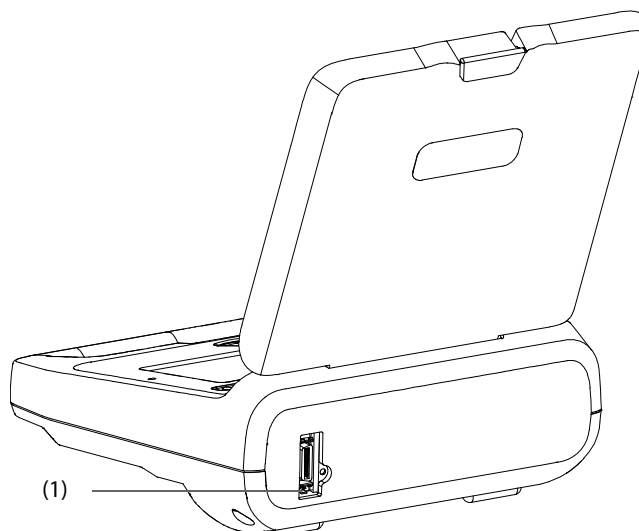

- (1) Multifunction connector (for equipment configured with the CPR sensor): connects the CPR sensor.

3 Getting Started

3.1 Preparation Safety Information

WARNING

- The equipment shall be installed by personnel authorized by the manufacturer.
 - The software copyright of the equipment is solely owned by the manufacturer. No organization or individual shall resort to altering, copying, or exchanging it or to any other infringement on it in any form or by any means without due permission.
 - Devices connected to the equipment must meet the requirements of the applicable IEC standards (e.g. IEC 60950 safety standards for information technology equipment and IEC 60601-1 safety standards for medical electrical equipment). The system configuration must meet the requirements of the IEC 60601-1 medical electrical systems standard. Any personnel who connect devices to the equipment's signal input/output port is responsible for providing evidence that the safety certification of the devices has been performed in accordance to the IEC 60601-1. If you have any question, please contact the manufacturer.
 - If it is not evident from the equipment specifications whether a particular combination is hazardous, for example, due to summation of leakage currents, consult the manufacturers or else an expert in the field, to ensure the necessary safety of all devices concerned will not be impaired by the proposed combination.
-

CAUTION

- Make sure that the operating environment of the equipment meets the specific requirements. Otherwise unexpected consequences, e.g. damage to the equipment, could result.
 - The equipment might be contaminated during storage and transport. Before use, please verify whether the packages are intact, especially the packages of single use accessories. In case of any damage, do not apply it to patients.
-

NOTE

- Save the packing case and packaging material as they can be used if the equipment must be reshipped.
-

3.2 Equipment Installation

3.2.1 Unpacking and Checking

Before unpacking, examine the packing case carefully for signs of damage. If any damage is detected, contact the carrier, your local distributor or the manufacturer.

If the packing case is intact, open the package and remove the equipment and accessories carefully. Check all materials against the packing list and check for any mechanical damage. If you have any question, please contact your local distributor or the manufacturer.

3.2.2 Environmental Requirements

The operating environment of the equipment must meet the requirements specified in this manual.

The environment where the equipment is used shall be reasonably free from noises, vibration, dust, corrosive, flammable and explosive substances. If the equipment is installed in a cabinet, sufficient space in front and behind shall be left for convenient operation, maintenance and repair. Moreover, to maintain good ventilation, the equipment shall be at least 2 inches (5 cm) away from the sides of the cabinet.

When the equipment is moved from one place to another, condensation may occur as a result of temperature or humidity difference. In this case, never start the system before the condensation disappears.

3.2.3 Connecting the Electrode Pads

1. Open the socket cover, and plug the pads connector into the pads socket.
2. Put the socket cover back. Ensure the socket cover is centered and closed.
3. Place the pads package into the pads package holders properly and carefully. Ensure the expiration date of pads can be viewed from the pad expiration window.



4. Route the pads cable in the pad package holders.



WARNING

- **Keep the pads cable connected to the equipment at all times.**
 - **Do not open sealed pads until immediately prior to use.**
 - **Do not bend the electrode pads forcefully.**
 - **Make sure the pads package is intact before use. Otherwise, replace it with a new one.**
-

3.3 Turning on the Equipment

Before turning on the equipment, perform the following inspections:

- Check for mechanical damage on the equipment or other damage on the pads package.
- Make sure the pads cable is properly connected and battery installed.
- Check the expiration date of the pads on the pads package.

Open the AED lid, then the equipment automatically powers on.

3.4 Switching Voice Language

You can press the Language button until the desired language is selected. At most three voice languages can be configured.

3.5 Turning off the Equipment

Before turning off the equipment, perform the following inspections:

1. Confirm that the patient therapy is completed.
2. Disconnect the electrode pads from the patient.

To turn off the equipment, close the AED lid.

WARNING

- **If the patient is not connected to the equipment, and no operation is found performed on the equipment within 30 minutes, the equipment will automatically shut down.**
-
-

This page intentionally left blank.

4 Using the Equipment

4.1 Operating Safety Information

DANGER

- Avoid contact between parts of the patient's body such as exposed skin of head or limbs, conductive fluids such as gel, blood, or saline, and metal objects such as a bed frame or a stretcher which may provide unwanted pathways for the defibrillating current.
-

WARNING

- The equipment automatically removes the stored energy internally in following conditions.
 - ◆ A rhythm change is detected and a shock is no longer appropriate.
 - ◆ Electrode pads malfunction is detected.
 - ◆ The Shock button is not pressed within 30s on the semi-automatic models.
 - Performing CPR or otherwise handling or moving the patient during rhythm analysis can cause incorrect or delayed analysis.
 - For safety reasons, some low-amplitude or low-frequency heart rhythms as well as some VT rhythms may not be interpreted as shockable rhythms.
 - During defibrillation, air pockets between the skin and the electrode pads can cause patient skin burns. To help prevent air pockets, make sure the electrode pads are completely adhered to the skin.
 - During defibrillation, never press the Adult/Child mode switch to the Adult mode when using pediatric pads for children. Otherwise the electrode pads might be damaged and could result in delayed analysis.
 - Do not use dried-out electrode pads.
-

CAUTION

- Prevent the electrode pads from contamination by dust or water before they are attached to the patient. Otherwise, incorrect or delayed analysis may result.
-

NOTE

- Use pediatric pads for children. If pediatric pads are not available, you can use adult pads, press the Adult/Child mode switch to the Child mode and apply the electrode pads.
 - If MR62/MR63 electrode pads are used, the equipment automatically recognizes the patient type after power on. When the current patient type is found to be inconsistent with the pad type, you need to manually change the patient type.
 - If needed, perform CPR when there is delay or interruption in using of the equipment.
 - Successful resuscitation is dependent on many variables specific to the patient's physiological state and the circumstances surrounding the patient event. Failure to have a successful patient outcome is not a reliable indicator of defibrillator/monitor performance. The presence or absence of a muscular response to the transfer of energy during electrical therapy is not a reliable indicator of energy delivery or device performance.
 - In emergency, if there are no spare pads nearby, continue patient treatment with the expired electrode pads and ignore pads related prompts.
 - Motion artifact may delay analysis or affect the ECG signal resulting in an inappropriate shock or no shock advised message. Keep the patient still during ECG rhythm analysis.
 - For the semi-automatic models, the Shock button must be pressed to deliver a shock. The equipment will not automatically deliver a shock.
-

- Impedance is the resistance between the electrode pads that the defibrillator must overcome to deliver an effective discharge of energy. The degree of impedance differs from patient to patient and is affected by several factors including the presence of chest hair, moisture, and lotions or powders on the skin. If the “Shock canceled. Press pads firmly to patient's bare skin” voice prompt is provided, make sure that the patient’s skin has been dried and chest hair has been clipped. If the prompt persists, change the electrode pads.

4.2 Screen Display (for Equipment Configured with the Screen)

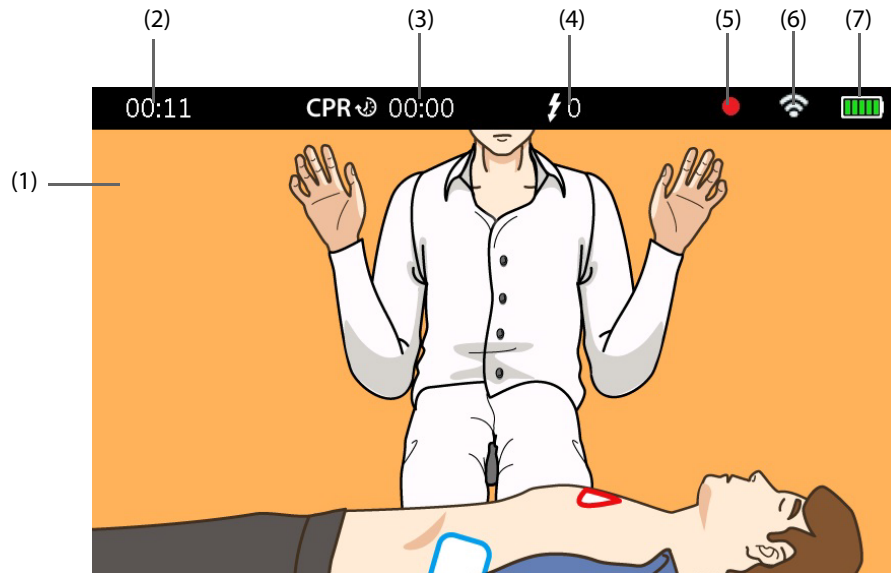

- (1) ECG rhythm: displays one ECG waveform acquired from the electrode pads if **ECG Display** is set to **On**.
- (2) Runtime area: displays the equipment's operating time since powered on.
- (3) CPR time
- (4) Number of delivered shocks
- (5) Record icon: available when the sound recording function is enabled.
- (6) Network type indicator
 -  : indicates the equipment is configured with the Wi-Fi module, and is connected to the AED ALERT system through the Wi-Fi network.
 - **4G**: indicates the equipment is configured with the cellular module, and is connected to the AED ALERT system through the cellular network.
- (7) Battery status indicator: indicates battery status. For details, see *6 Battery*.

4.3 Responds to a Rescue

You should perform the general steps for a rescue.

1 Assess the Patient



Confirm that the patient is both:

- Unresponsive,
- Not breathing or not breathing normally

CALL EMERGENCY MEDICAL SERVICE!

2 Turn on the Equipment



Open the lid.

You hear:

🔊 Powered on. Stay calm. Follow the instructions.

3 Check Patient Category



Flip the Adult/Child mode switch left or right:

- For an adult: 8 years and older or over 25kg

You hear:

🔊 Adult mode

- For a child: under 8 years old or under 25kg

You hear:

🔊 Child mode

4 Prepare the Patient

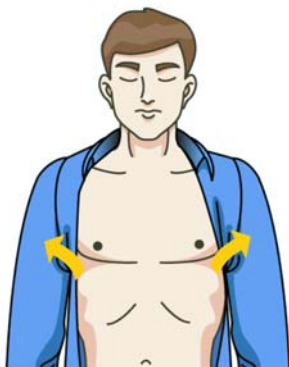

Expose the patient's bare chest:

- Ensure the patient's skin is clean and dry.
- Dry the patient's chest and shave excessive hair if necessary.

You hear:

🔊 Remove clothing from patient's chest. Apply pads as shown on Pads.

5 Apply the Electrode Pads

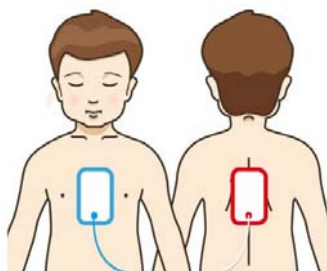
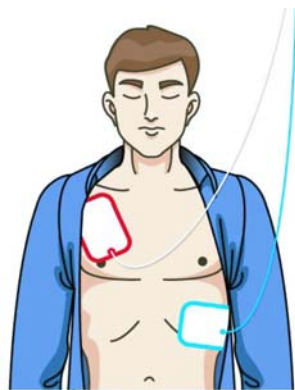

Apply the electrode pads to the patient as directed on the pads package.

For an adult:

- Blue (apex) pad placement: place the blue pad as the blue area (below left nipple, on the left anterior axillary line) illustrated in the picture
- Red (sternum) pad placement: place the red pad as the red area (below the clavicle, lateral to the sternum) illustrated in the picture

For a child:

- Blue (apex) pad placement: place the blue pad as the blue area (on the chest middle line) illustrated in the picture
- Red (sternum) pad placement: place the red pad as the red area (on the back middle line) illustrated in the picture

You hear:

🔊 Apply pads firmly to patient's bare chest as shown on Pads.

6 Analyze Heart Rhythm



Do not touch the patient, waits for heart rhythm analysis.

You hear:

🔊 Do not touch the patient. Analyzing heart rhythm.

7 Deliver a Shock

If Shock Advised

- For fully automatic models:
The equipment automatically shocks the patient.

You hear:

🔊 Shock advised. Everyone clear.
Shock will be delivered in: 3, 2, 1

- For semi-automatic models:
Press the Shock button within 30s.

You hear:

🔊 Shock advised. Everyone clear. Press flashing shock button.



If No Shock Advised

Go to Step 8.

You hear:

🔊 No shock advised.

8 Perform CPR

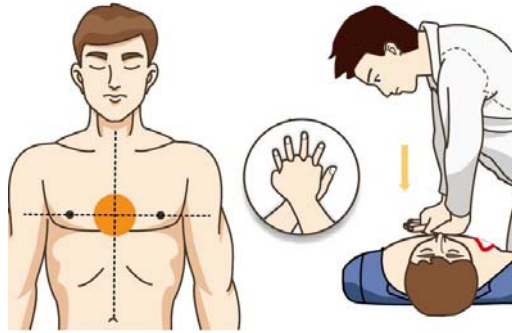

Perform CPR according to the prompts.

- If the CPR time expires, repeat Step 6.
- If the patient is conscious and breathing normally, wait for emergency medical services to arrive.

4.4 Performing CPR

The equipment enters the CPR status in the following conditions.

- Non-shockable rhythm is detected with a prompt **"No shock advised"**.
- After a shock delivered and heart rhythm analysis pauses.

CPR status continues for 2 minutes.

WARNING

- **Performing CPR with the electrode pads attached on the patient might damage the electrode pads. In this case, replace the electrode pads.**
-
-

4.4.1 Using the CPR Metronome

The equipment provides a CPR metronome feature that can be used to encourage rescuers to perform chest compression and ventilation at AHA/ERC recommended rate.

WARNING

- **The CPR metronome sounds do not indicate information regarding the patient's condition. Because patient status can change in a short time, the patient should be assessed at all times. Do not perform CPR on a patient who is responsive or is breathing normally.**
-
-

4.4.2 Using the CPR Sensor

The equipment provides voice instructions about real-time compression feedbacks if it is connected with a CPR sensor.

NOTE

- **The CPR sensor is not available in the markets of UK, Germany and France.**
-
-

To connect the CPR sensor, follow this procedure.

1. Hold one end of the CPR sensor cable, and plug it into the CPR sensor connector.
2. Fasten the CPR sensor cable with the cable retainer.
3. Try to pull the CPR sensor cable to make sure that the cable is securely connected.

4. Plug the other end of the sensor cable into the CPR sensor connector of the equipment.

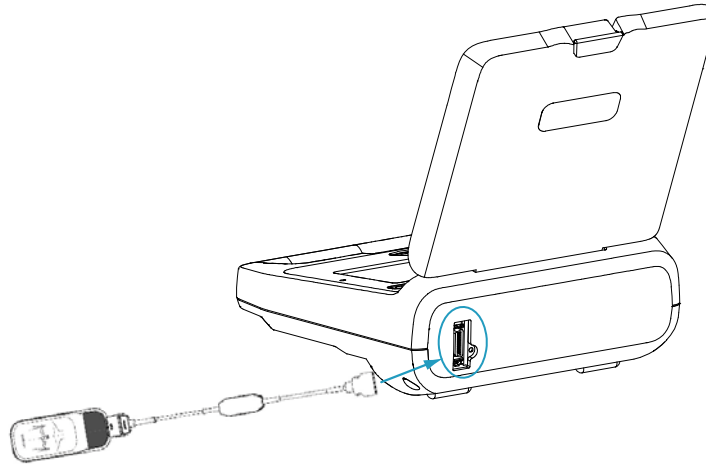

For more information on using the CPR sensor, see *MR6401 CPR Sensor Operator's Manual*.

4.5 Preparation for Next Rescue

1. Retrieve the rescue data stored in the equipment. For more information, see *5 Data Management*.
2. Squeeze the pads connector, and hold it back to remove the pads connector.



3. Replace with the new electrode pads. For more information, see *3.2.3 Connecting the Electrode Pads*.
4. Ensure the Adult/Child mode switch is available by flipping it right or left.
5. Close the lid and check the Status indicator illuminates in green.

5 Data Management

5.1 Data Management Overview

The following table lists data stored in the equipment and how to manage these data.

Data Type		Description	Management Method
Patient Data	ECG data	Heart rhythm	Contact your local distributor.
	Events	AED analysis, CPR operation, system operations and prompts	
	Recordings	Audio recorded during a rescue	
	Rescue data	Total rescue time, CPR duration, total shocks	
	CPR data	Compression rate and depth provided by using the CPR sensor.	
Configurations		Configurable setup options	AED Tool software
Equipment information		Equipment model, serial number, software version, total runtime, battery information, electrode pads information, total auto tests	
Equipment status		Powered on, powered off, out of location	AED ALERT Device Management system
Auto test data		Last selftest report, fault codes if auto test fails	

NOTE

- **The equipment is capable of 1 Gbit internal data storage.**

5.2 Generating a Patient File

Once turned on, the equipment automatically generates a patient ID and starts to record clinical data for this ID. If turned off, the equipment automatically discharges the patient, and the patient becomes a discharged patient.

NOTE

- **Earlier stored data will be overwritten by later ones if the equipment capacity is reached.**

5.3 Managing Configurations

If you purchase the AED Tool software, you can:

- Viewing equipment Information
- Viewing configurations
- Changing configurations
- Restoring to the factory default configurations

For more information on specific operations, see *AED Tool Instructions for Use*.

CAUTION

- **The configurations can only be changed by trained equipment managers. To change the configurations, contact the equipment manager at your facility.**
-

5.4 AED ALERT System Overview

The equipment can be connected to the AED ALERT Device Management system, hereinafter called the AED ALERT system, through a Wi-Fi or cellular network. With the AED ALERT system, you can view data uploaded from the equipment and manage your equipment. The AED ALERT system should be used by emergency equipment managers at your facility.

The AED ALERT system may provide the following features, depending on your subscription type and service area.

- Managing equipment, such as register, edit, delete, import or export the equipment information.
- Managing users, such as create a secondary account, edit or delete the user information.
- Managing rescuers, such as associate a rescuer with the equipment, edit, delete or import the rescuer information.
- Making statistics for registered equipment and rescuers, giving brief statistical graphs.
- Viewing the equipment information
- Monitoring equipment status and sending email or message notifications when the equipment is turned on or off.
- Instructing a lost equipment by sending its approximate location (only available for a cellular connection)
- Sending email notifications when auto test fails, no auto test detected, low battery or expired electrode pads.
- Giving alerts for the electrode pads nearing the expiration date.

For more information on specific system operations, see Online Help of the AED ALERT system.

NOTE

- **If any equipment failure is found or no equipment information is displayed when using the AED ALERT system, the equipment manager must go to the scene to clear the failure.**
 - **The AED ALERT system is not available in all countries.**
-

5.5 Accessing the AED ALERT System

If the equipment is connected to the AED ALERT system through the wireless network, you can access the system on the Internet.

To access the AED ALERT system, follow this procedure.

1. Input <https://aed-alert.mindray.com> in the Browser address bar.
2. Input the user name and password.
3. Click [**Login**].

6 Battery

6.1 Battery Introduction

The equipment is designed to operate using a disposable battery.

6.2 Battery Safety Information

WARNING

- **Never charge the disposable battery under any circumstances.**
 - **Do not disassemble, puncture or incinerate batteries. Do not short the battery terminals. They may ignite, explode, or leak, causing personal injury.**
 - **Keep a new spare battery available at all times.**
 - **Battery operating time depends on the time and frequency of using the equipment. Improper use of the battery will reduce its operating time.**
-

NOTE

- **Battery operating time depends on the ambient temperature, equipment configuration and operation.**
 - **Poor network quality connecting AED ALERT system will reduce the battery standby life.**
-

6.3 Battery Indications

On-screen battery symbols, battery related voice prompts indicate the current battery status.

6.3.1 Battery Power Indicators (for Equipment Configured with the Screen)

The on-screen power indicator indicates the battery status. The power indicator consists of 5 portions, each portion represents a charge of approximately 20% of capacity.



indicates that battery works correctly. The green portion represents the remaining charge.



indicates that the battery power is low or almost depleted. You need to replace the battery immediately.

6.3.2 Battery Prompts

If the battery has low charge, voice prompts will be given. In this case, you should take actions by referring to the following table.

Voice Prompt	Recommended Action
Low Battery! Please replace battery as soon as possible	The battery charge is low. Replace the battery with a new battery immediately. If not, this voice prompt will be repeated every five minutes.
Battery Depleted! Please replace battery immediately	The battery is almost depleted. Replace the battery with a new battery immediately. If not, this voice prompt will be repeated every minute and the equipment automatically shuts down in three minutes.

6.4 Replacing the Battery

Before replacing the battery, perform the following inspections.

- Make sure the equipment is turned off.
- Make sure the battery to be replaced is intact.

To replace the battery, follow this procedure.

1. Place the equipment on the worktable with face down.
2. Remove the screws from the battery door.
3. Remove the battery door as indicated.

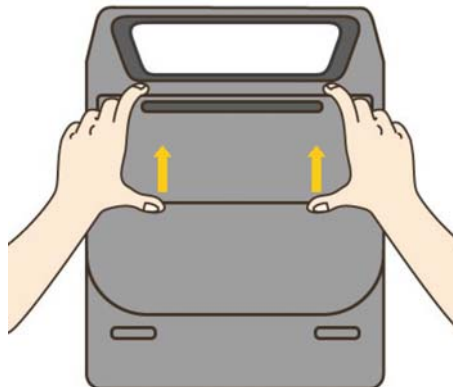

4. Slide the battery to the left, and lift it to remove from the battery compartment.



5. Align the battery pins, slide the battery into the battery compartment until it clicks into place.
6. Re-install the battery door with the screws.
7. Perform the test by referring to [8.3.1 User Test](#).

NOTE

- **Install and use the battery before the expiration date displayed on the battery label.**
 - **Never remove the battery unless the equipment indicates to do so.**
 - **Make sure the battery door is reinstalled properly to protect the equipment and battery.**
-

6.5 Storing Batteries

When storing batteries, make sure that the battery terminals do not come into contact with metallic objects. If batteries are stored for an extended period of time, they should be placed in a cool place

NOTE

- **Storing batteries at temperature above 38 °C (100 °F) for an extended period of time significantly shortens the battery operating time and standby life .**
 - **The battery storage temperature is between -5 °C and 35 °C. Storing batteries in a cool place can slow the aging process. Ideally the batteries should be stored at 15 °C.**
-

6.6 Recycling Batteries

Discard a battery in the following situations:

- The battery has visual signs of damage.
- The battery fails.

Properly dispose of batteries according to local regulations.

This page intentionally left blank.

7 Care and Cleaning

Use only the substances approved by the equipment manufacturer and methods listed in this chapter to clean or disinfect your equipment. Warranty does not cover damages caused by unapproved cleaning and disinfection substances or methods.

Mindray makes no claims regarding the efficacy of the listed chemicals or methods as a means for controlling infection. For the method to control infection, Mindray advises you to consult your local hospital's Infection Control Officer or epidemiologist.

7.1 General Points

Keep your equipment and accessories free of dust and dirt. To avoid damage to the equipment, follow these rules:

- Always dilute following the manufacturer's instructions or use lowest possible concentration.
- Do not immerse part of the equipment into liquid.
- Do not pour liquid onto the equipment or accessories.
- Do not allow liquid to enter the case.
- Never use abrasive materials (such as steel wool or silver polish), or erosive cleaners (such as acetone or acetone-based cleaners).

WARNING

- **The equipment manager shall carry out all cleaning and disinfection procedure specified in this chapter.**
- **Be sure to shut down the system and remove the battery before cleaning the equipment.**

CAUTION

- **Contact your service personnel in case of spilling liquid on the equipment or accessories.**
-

7.2 Cleaning

Your equipment should be cleaned on a regular basis. If there is heavy pollution or lots of dust and sand in your location, the equipment should be cleaned more frequently. Before cleaning the equipment, consult your facility's regulations for cleaning the equipment.

Recommended cleaning agents are:

- Water
- Sodium hypochlorite bleach (10%, Sodium hypochlorite)
- Hydrogen peroxide (3%)
- Ethanol (75%)
- Isopropyl alcohol (70%)
- Perform® classic concentrateOXY (KHSO₄ solution)

To clean your equipment, follow these rules:

1. Shut down the equipment, disconnect cables, and remove the battery.
2. Clean the display screen using a soft, clean cloth dampened with a glass cleaner.
3. Clean the exterior surface of the equipment using a soft, clean cloth dampened with a glass cleaner.
4. Wipe off all the cleaning solution with a dry cloth after cleaning if necessary.
5. Dry your equipment in a ventilated, cool place.

7.3 Disinfecting

Disinfect the equipment as required in your facility servicing schedule. Cleaning equipment before disinfecting is recommended.

7.4 Sterilization

Sterilization is not recommended for the equipment unless otherwise indicated in the Instructions for Use that accompany the product.

8 Maintenance and Testing

8.1 Maintenance Introduction

Regular maintenance is essential to ensure that the equipment functions properly. This chapter contains information on periodic testing and maintenance. For details about the electrical safety test, see *BeneHeart C & S Series Automatic External Defibrillator Service Manual*.

8.2 Maintenance Safety Information

WARNING

- Failure for the responsible institution employing this equipment to implement a satisfactory maintenance schedule may cause undue equipment failure and delayed analysis.
 - No modification of this equipment is allowed.
 - This equipment contains no user serviceable parts.
 - The safety checks or maintenance involving any disassembly of the equipment should be performed by professional servicing personnel. Otherwise, undue equipment failure and possible health hazards could result.
 - The service personnel must be properly qualified and thoroughly familiar with the operation of the equipment.
-

CAUTION

- Do not perform any functional check and maintenance if the equipment is connected to a patient; otherwise the patient might be shocked.
 - If you discover a problem with any of the equipment, contact your local distributor, service personnel or Mindray.
 - Use and store the equipment within the specified temperature, humidity, and barometric ranges.
 - When disposing of the packaging material, be sure to observe the applicable waste control regulations and keep it out of children's reach.
-

NOTE

- If needed, contact the manufacture for circuit diagrams, component part lists, descriptions, calibration instructions, or other information concerning the repair of the equipment.
-

8.3 Performing Maintenance

To ensure that the equipment is ready for operation at any time, perform the following tests as recommended:

Maintenance Item	Recommended Frequency	Test Item
User test	<ul style="list-style-type: none"> After installing the battery After replacing the battery After each use 	Performs function tests of the main control module, the therapy module, the power module, electrode pads, 1J charge and discharge, 360J charge and discharge, controls, the speaker.
Auto test	Automatically, whenever the equipment is powered on, or when a battery is installed.	Performs function tests of the main control module, the therapy module, the power module
	Once a day	Performs function tests of the main control module, the therapy module, the power module, electrode pads expiration, 1J charge and discharge
	Once a week	
	Once a month	Performs function tests of the main control module, the therapy module, the power module, electrode pads expiration, 1J charge and discharge, 200J charge and discharge, the speaker.
Once a quarter	Performs function tests of the main control module, the therapy module, the power module, electrode pads expiration, 1J charge and discharge, 360J charge and discharge, the speaker.	
Electrode pads check	Once a month	Checks the electrode pads are not expired.

The equipment connected to the AED ALERT system can be managed remotely, which could reduce the site maintenance. All the maintenances performed on the AED ALERT system must be in compliance with the local regulations.

NOTE

- Auto test checks the expiration of electrode pads only when the electrode pads have such function.

8.3.1 User Test

You can use the already installed battery or a replaced battery to perform the user test on the equipment.

To perform the battery installation test, follow this procedure:

- Choose any of the following ways to start the test.
 - Install the battery for the first time or replace the battery after it is taken out for over three minutes.
 - Not taking out the battery, hold the Language button for 5s and flip the Adult/Child mode switch twice.
 - Not taking out the battery, hold the Shock button for 5s and flip the Adult/Child mode switch twice.
- Perform operations following the voice instructions.

All items are tested hereafter automatically after you respond to the equipment. If any failure is detected, corresponding prompts are provided.

You can also perform the user test using the AED Tool software. For more information, see *AED Tool Instructions for Use*.

CAUTION

- Frequently turning on or off the equipment during the user test will reduce the battery standby life.

8.3.2 Auto Test

The equipment with a battery installed carries out auto test at the configured time even when powered off to check the equipment's operational performance and alert the operator if a problem exists. Auto test is initiated at 3:00 am every day by default.

The equipment provides no voice prompts during auto test. The test result can be checked on the status indicator:

- Flashes in green: the auto test passes, an auto-test report is saved automatically when the test is completed.
- Flashes in red: the auto test fails. If the equipment is connected to the AED ALERT system, an auto-test report is saved and uploaded automatically to the system when the test is completed.

Mindray recommends you check the status indicator every day, and record the result according to *G Inspection Record*.

CAUTION

- **With the equipment powered off, auto test can be performed only when the battery is installed.**

NOTE

- **When the equipment is placed at a temperature below -20°C, the auto test cannot be carried out, and incorrect status indication could result.**
-

8.3.3 Electrode Pads Check

The expiration date of electrode pads should be checked every month. You can check the expiration date from the pad expiration window, and record it according to *G Inspection Record*.

8.4 Disposing the Equipment

Dispose of the equipment and its accessories when its service life is reached. Follow local regulations regarding the disposal of such product.

WARNING

- **For disposal of parts and accessories, where not otherwise specified, follow local regulations regarding disposal of hospital waste.**
-

This page intentionally left blank.

9 Accessories

The accessories listed in this chapter comply with the requirements of IEC 60601-1-2 when in use with the equipment. The accessory material that contacts the patients has undertaken the bio-compatibility test and is verified to be in compliance with ISO 10993-1. For details about the accessories, refer to the instructions for use provided with the accessory.

WARNING

- **Use accessories specified in this chapter. Using other accessories may cause damage to the equipment or not meet the claimed specifications.**
- **Single-use accessories are not designed to be reused. Reuse may cause a risk of contamination and affect the measurement accuracy.**

CAUTION

- **The accessories may not meet the performance specifications if stored or used outside the specified temperature and humidity ranges. If accessory performance is degraded due to aging or environmental conditions, contact your service personnel.**
- **Check the accessories and their packages for any sign of damage. Do not use them if any damage is detected.**
- **Use the accessories before the expiry date if their expiry date is indicated.**
- **The disposable accessories shall be disposed of according to local regulations.**

9.1 Therapy Accessories

Description	Model	Applicable patient	Remark	PN
Multifunction electrode pads	MR60	Adult, Child	Disposable (5 sets/pack)	0651-30-77007
	MR61	Child		0651-30-77008
	MR62	Adult, Child	Disposable (5 sets/pack), the adult pads are automatically detected, the pediatric pads need to be manually selected.	115-035426-00
	MR63	Child	Disposable (5 sets/pack), the pediatric pads are automatically detected.	115-035427-00
CPR sensor	MR6401	/	Reusable, without a battery	115-044803-00
CPR sensor cable	MR6801	/	Reusable	040-003096-00
CPR adhesive tape	MR6921	/	Disposable (3 sets/pack)	040-003123-00

9.2 Miscellaneous

Description	Model	PN
Disposable battery	LM34S002A	022-000411-00

A Specifications

A.1 Safety Specifications

The equipment is classified, according to IEC 60601-1:

Type of protection against electrical shock	Equipment energized from an internal electrical power source (battery).
Degree of protection against electric shock	Type BF defibrillation proof for external defibrillation.
Mode of operation	Continuous
Degree of protection against harmful ingress of solid	IP5X
Degree of protection against harmful ingress of water	IPX5
Degree of mobility	Portable

A.2 Environmental Specifications

Item	Temperature	Relative humidity	Barometric
Operating conditions	-5°C to 50°C (at least 60 minutes of working time when the temperature reduces from room temperature to -20°C)	5% to 95%, non-condensing	57.0 to 106.2 kPa (-381 m to 4575m)
Short-Term Storage conditions	-30°C to 70°C	5% to 95%, non-condensing	57.0 to 106.2 kPa (-381 m to 4575m)
Long-Term Storage conditions	15°C to 35°C		

Shock

Complies with requirements of 21.102, ISO9919:
 Peak acceleration: 1000m/s² (102g)
 Duration: 6ms
 Pulse shape: half-sine
 Number of shocks: 3 shocks per direction per axis (18 total)

Vibration

Complies with requirements of 21.102, ISO9919.

Bump

Complies with the requirements of 6.3.4.2, EN1789.
 Peak acceleration: 15g
 Duration: 6ms
 Number of impacts: 1000
 Impact direction: vertical impacts are applied when the equipment under test is placed at normal operating position.

Drop
1.5 m per IEC 68-2-32, 1 on each of the six surfaces.

CAUTION

- The equipment may not meet the performance specifications if stored or used outside the specified temperature and humidity ranges. If the performance of the equipment is degraded due to aging or environmental conditions, contact your service personnel.

A.3 Physical Specifications

Main Unit	Size (Width × depth × height)	Weight
BeneHeart C1/BeneHeart C1A/ BeneHeart S1/BeneHeart S1A	21.0 cm×28.6 cm×7.8 cm (± 2cm)	2.0 ± 0.3 kg, including one battery, excluding the Wi-Fi and cellular modules.
BeneHeart C2/BeneHeart C2A/ BeneHeart S2/BeneHeart S2A		2.3 ± 0.3 kg, including one battery, excluding the Wi-Fi and cellular modules.
BeneHeart C1 Fully Automatic/ BeneHeart C1A Fully Automatic/ BeneHeart S1 Fully Automatic/ BeneHeart S1A Fully Automatic		2.0 ± 0.3 kg, including one battery, excluding the Wi-Fi and cellular modules.
BeneHeart C2 Fully Automatic/ BeneHeart C2A Fully Automatic/ BeneHeart S2 Fully Automatic/ BeneHeart S2A Fully Automatic		2.3 ± 0.3 kg, including one battery, excluding the Wi-Fi and cellular modules.

A.4 Display Specifications (for Equipment Configured with the Screen)

Type	TFT Color LCD
Brightness	Auto, Outdoor Mode, Indoor mode. In the auto mode, the equipment automatically adjusts the screen brightness according to the ambient light.
Size	7 inch
Resolution	800×480 pixels
Viewed waveforms	1
Wave viewing time	Max. ≥ 6s (ECG)

A.5 Audio Indicators

Speaker	Gives prompt tones (65 dB to 78 dB). Supports multi-level tone modulation.
---------	---

A.6 Interface Specifications

USB connector	1, USB 2.0
micro USB connector	1, supports Windows 7 or above operating system
Network connector	1, connects the Wi-Fi or cellular (2G/3G/4G) network.
Multifunction connector	1, connects the CPR sensor.

A.7 Battery Specifications

Battery type	Disposable battery	
Battery voltage	12V	
Battery capacity	4200mAh	
Equipment configured without the screen	Operating time	Testing condition
	≥ 15 hours	The equipment is powered by a new battery at 20 °C± 5 °C of ambient temperature, wireless function off, not performing defibrillation charges or discharges, voice volume set to low.
	300 200J discharges	The equipment is powered by a new battery at 20 °C± 5 °C of ambient temperature, wireless function off, voice volume set to low, with one minute of CPR between discharges
	190 360J discharges	
	510 150 J discharges	The equipment is powered by a new battery at 20 °C± 5 °C of ambient temperature, wireless function off, voice volume set to low, with three discharges every minute
	400 200J discharges	
	200 360J discharges	
Equipment configured with the screen	≥ 12 hours	The equipment is powered by a new battery at 20 °C± 5 °C of ambient temperature, wireless function off, not performing defibrillation charges or discharges, voice volume set to low.
	270 200J discharges	The equipment is powered by a new battery at 20 °C± 5 °C of ambient temperature, wireless function off, voice volume set to low, with one minute of CPR between discharges
	170 360J discharges	
	450 150J discharges	The equipment is powered by a new battery at 20 °C± 5 °C of ambient temperature, wireless function off, voice volume set to low, with three discharges every minute
	350 200J discharges	
	200 360J discharges	
Battery fuel gauge (for equipment configured with the screen)	Battery symbol on the display indicating the current battery level	

Remaining charge after “Low Battery” is prompted	For BeneHeart C1/BeneHeart C1A/BeneHeart C1 Fully Automatic/ BeneHeart C1A Fully Automatic/BeneHeart S1/BeneHeart S1A/BeneHeart S1 Fully Automatic/BeneHeart S1A Fully Automatic:	
	<ul style="list-style-type: none"> • At least 30 minutes operating time (at 20 °C± 5 °C of ambient temperature, wireless function off, voice volume set to low) and at least 10 200J discharges (with one minute of CPR between discharges) • At least 30 minutes operating time (at 20 °C± 5 °C of ambient temperature, wireless function off, voice volume set to low) and at least 6 360J discharges (with one minute of CPR between discharges) 	
Battery standby life	For BeneHeart C2/BeneHeart C2A/BeneHeart C2 Fully Automatic/ BeneHeart C2A Fully Automatic/BeneHeart S2/BeneHeart S2A/BeneHeart S2 Fully Automatic/BeneHeart S2A Fully Automatic:	
	<ul style="list-style-type: none"> • At least 30 minutes operating time (at 20 °C± 5 °C of ambient temperature, wireless function off, voice volume set to low, screen brightness set to indoor mode) and at least 10 200J discharges (with one minute of CPR between discharges) • At least 30 minutes operating time (at 20 °C± 5 °C of ambient temperature, wireless function off, voice volume set to low, screen brightness set to indoor mode) and at least 6 360J discharges (with one minute of CPR between discharges) 	
	Standby life	Testing condition
	5 years	The equipment is powered by a new battery at 20 °C± 5 °C of ambient temperature, performing auto test every day, equipment not in use, not sending selftest report
	3 years	The equipment is powered by a new battery at 20 °C± 5 °C of ambient temperature, performing auto test every day, equipment not in use, sending selftest report every week through the wireless network
	2 years	The equipment is powered by a new battery at 20 °C± 5 °C of ambient temperature, performing auto test every day, equipment not in use, sending selftest report every day through the wireless network

CAUTION

- **If the equipment is connected through the wireless network in low strength signal, the battery standby life will be shortened.**
-

A.8 Data Storage

Waveform storage	Up to 5 hours of ECG waveforms
Events	Up to 500 events
Voice recording	Up to 1 hour
CPR data	Up to 5 hours
Selftest reports	1000 records

A.9 Wireless Specifications

Wi-Fi	
Standard	IEEE 802.11 a/b/g/n
Operating frequency	IEEE 802.11 b/g/n (at 2.4G): 2.412 GHz to 2.472 GHz IEEE 802.11 a/n (at 5G): 5.18 GHz to 5.24 GHz, 5.745 GHz to 5.825 GHz
Data security	Standards: WPA-PSK, WPA2-PSK, WPA-Enterprise, WPA2-Enterprise EAP method: EAP-TLS, PEAP-GTC, PEAP- MSCHAPv2 Encryption: TKIP, AES
Modulation mode	DSSS and OFDM
Cellular	
Operating frequency	LTE-FDD B1: 1920 MHz to 1980 MHz, 2110 MHz to 2170 MHz LTE-FDD B3: 1710 MHz to 1785 MHz, 1805 MHz to 1880 MHz LTE-FDD B7: 2500 MHz to 2570 MHz, 2620 MHz to 2690 MHz LTE-FDD B8: 880 MHz to 915 MHz, 925 MHz to 960 MHz LTE-FDD B20: 832 MHz to 862 MHz, 791 MHz to 821 MHz LTE-FDD B28A: 703 MHz to 733 MHz, 758 MHz to 788 MHz LTE-TDD B38: 2570 MHz to 2620 MHz LTE-TDD B40: 2300 MHz to 2400 MHz
Standard/Modulation mode	3GPP E-UTRA Release 11: LTE-FDD/LTE-TDD

A.10 Defibrillator Specifications

Standards	Meet standards of IEC 60601-2-4
Defibrillation mode	<ul style="list-style-type: none"> BeneHeart C1/BeneHeart C1A/BeneHeart C2/BeneHeart C2A/BeneHeart S1/BeneHeart S1A/BeneHeart S2/BeneHeart S2A: semi automatic external defibrillation BeneHeart C1 Fully Automatic/BeneHeart C1A Fully Automatic/BeneHeart C2 Fully Automatic/BeneHeart C2A Fully Automatic/BeneHeart S1 Fully Automatic/BeneHeart S1A Fully Automatic/BeneHeart S2 Fully Automatic/BeneHeart S2A Fully Automatic/: fully automatic external defibrillation
Defibrillation waveform	Biphasic truncated exponential (BTE) waveform, auto-compensation according to patient impedance
Defibrillation electrodes	Multifunction electrode pads.
Range of selected energy	For adults: 100 J, 150 J, 170 J, 200 J, 300 J, 360 J. For children: 10 J, 15 J, 20 J, 30 J, 50 J, 70 J, 100 J.
Patient impedance range	25 to 300 Ω
Shock series	Energy level: 100 to 360J, configurable for adults. 10 to 100J, configurable for children. Shocks: 1, 2, 3, configurable; Meeting AHA/ECR guidelines 2015 by default.
ECG Analysis Performance	See <i>B Mindray Shockable Rhythm Analysis Algorithm</i> .

360 J defibrillation waveform into impedance of 25Ω, 50Ω, 75Ω, 100Ω, 125Ω, 150Ω, 175Ω

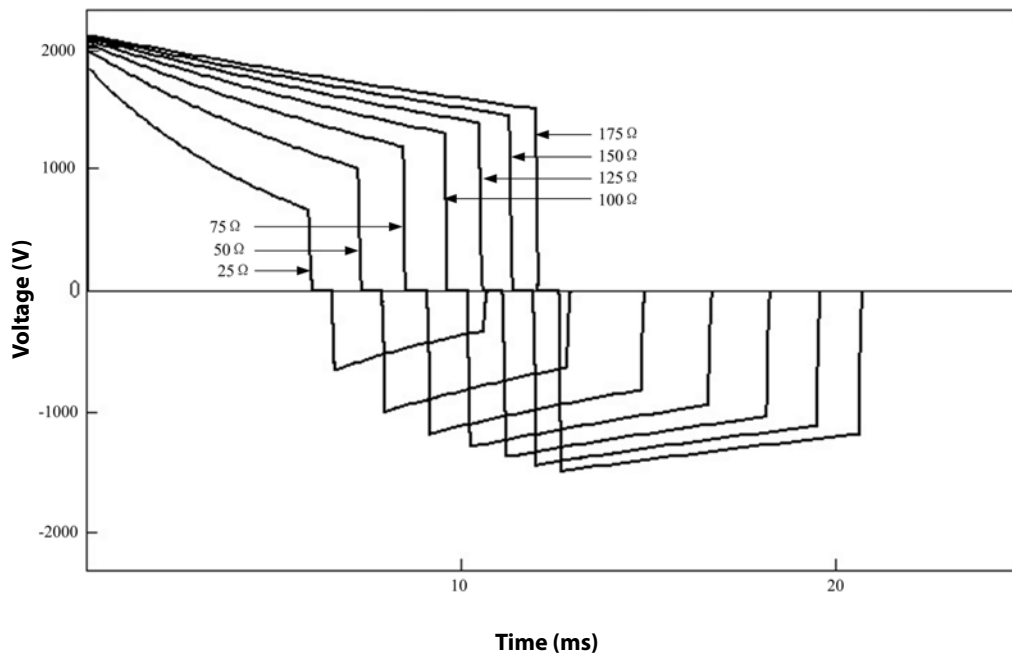

Selected energy accuracy								
Impedance \ Energy	25Ω	50Ω	75Ω	100Ω	125Ω	150Ω	175Ω	Accuracy
10 J	9.7 J	10 J	9.7 J	9.3 J	8.9 J	8.5 J	8.1 J	±10% or ±2J, whichever is greater
15 J	15 J	15 J	15 J	14 J	13 J	13 J	12 J	
20 J	20 J	20 J	20 J	19 J	18 J	17 J	16 J	
30 J	29 J	30 J	29 J	28 J	27 J	25 J	24 J	
50 J	49 J	50 J	49 J	47 J	45 J	43 J	41 J	
70 J	68 J	70 J	68 J	65 J	62 J	60 J	57 J	
100 J	97 J	100 J	97 J	93 J	89 J	85 J	81 J	
150 J	146 J	150 J	146 J	140 J	134 J	128 J	122 J	
170 J	166 J	170 J	166 J	159 J	151 J	145 J	138 J	
200 J	195 J	200 J	195 J	187 J	178 J	170 J	163 J	
300 J	292 J	300 J	292 J	280 J	267 J	255 J	244 J	
360 J	351 J	360 J	350 J	336 J	321 J	306 J	293 J	

Charge time (at 20 °C± 5 °C of ambient temperature)					
Battery status	From lid opened to charge done		From initiation of rhythm analysis to charge done		From initial power on to charge done
	200J	360J	200J	360J	
New battery	<8 s	<15 s	<5 s	<12 s	<7 s
New battery after 15 times of 360J discharges	<8 s	<15 s	<5 s	<12 s	<7 s

A.11 ECG Specifications (for Equipment Configured with the Screen)

ECG inputs	Multifunction electrode pads
Gain	Auto
Sweep speed	25 mm/s, error no more than $\pm 5\%$
Common mode rejection	>90 dB
Recovery time	<2.5 s (after defibrillation)

A.12 Electrode Pads Specifications

Electrode Pads	MR60	MR61	MR63	MR62
Electrode shape	Oval			
Cable length	1.2 m preconnectable			
Total area	148 cm ²	75 cm ²	75 cm ²	126 cm ²
Adhesive Area	145 cm ²	74 cm ²	74 cm ²	123 cm ²
Maximum Number of Defibrillation Shocks	Up to 50 shocks (360J monophasic and biphasic)			
Shelf life (with sealed package)	36 months			60 months
Storage Condition	0°C to 50°C			15°C to 35°C The shelf life assumes a storage temperature of 25°C. Storage temperature above 25°C will reduce the shelf life.

This page intentionally left blank.

B Mindray Shockable Rhythm Analysis Algorithm

The equipment configured with Mindray shockable rhythm analysis algorithm acquires and analyzes the patient's ECG signals to determine whether or not to give a defibrillation shock. If a shockable rhythm is detected, the algorithm recommends a defibrillation shock. If a nonshockable rhythm is detected, the algorithm recommends no shocks, avoiding unnecessary defibrillation shock to the patient.

Mindray shockable rhythm analysis algorithm has been validated by using the database for evaluation of Mindray algorithm performance.

B.1 Rhythm Recognition and Annotation Methodology

This section describes the recording method, rhythm source, rhythm selection criteria, annotation methods and criteria the database for evaluation of Mindray shockable rhythm analysis algorithm.

B.1.1 Database for Evaluation of Mindray Algorithm Performance

The database for evaluation of Mindray algorithm performance includes international standard database and Mindray clinical database for evaluating the ECG data. The ECG data for evaluation is selected according to AHA recommendations^a with a 10-second wave length.

Database for evaluation of Mindray shockable rhythm analysis algorithm includes:

- MIT-BIH: The Massachusetts Institute of Technology–Beth Israel Hospital Arrhythmia Database (from Holter)
- AHA: The American Heart Association Database for Evaluation of Ventricular Arrhythmia Detectors (from Holter)
- VFDB: MIT-BIH Malignant Ventricular Arrhythmia Database (from Holter)
- CU: The Creighton University Sustained Ventricular Arrhythmia Database [the third edition] (from hospital monitor)
- NST: The Noise Stress Test Database (12 ECG records of 30 minutes each plus 3 records of noise only - supplied with the MIT-BIH database)
- Mindray clinical data (from Mindray monitors, defibrillator monitors and automated external defibrillators)

B.1.2 Rhythm Categories

Each rhythm category for evaluating the ECG data has been confirmed by the clinical experts.

- Shockable rhythms
 - ◆ Coarse ventricular fibrillation (VF): amplitude $\geq 0.2\text{mV}$
 - ◆ Rapid ventricular tachycardia (VT): HR $\geq 150\text{bpm}$, QRS duration $\geq 120\text{ms}$
- Nonshockable rhythms
 - ◆ Normal sinus rhythm
 - ◆ Asystole: amplitude $< 0.1\text{mV}$
 - ◆ Atrial fibrillation/flutter, supraventricular tachycardias, sinus bradycardia, idioventricular rhythms, heart block, premature ventricular contractions, etc
- Intermediate rhythms
 - ◆ Fine ventricular fibrillation: $0.1\text{mV} < \text{amplitude} < 0.2\text{mV}$
 - ◆ Other VT: ventricular tachycardia that does not meet criteria for VT in the shockable rhythms category

B.2 Mindray Shockable Rhythm Analysis Algorithm Performance

Test results on the performance of the equipment configured with Mindray shockable rhythm analysis algorithm meet IEC 60601-2-4 requirements^b and AHA recommendations^a.

Test results on IEC 60601-2-4 requirements are shown below.

Rhythm category	Requirement	Test result
Shockable (sensitivity): Coarse VF Rapid VT	>90% >75%	Met Met
Nonshockable (specificity)	>95%	Met
Positive predictive value	Report only	>98%
False positive rate	Report only	<2%

Test results on AHA recommendations are shown below.

Rhythm category	Minimum sample size (cases)	Performance goal	Sample size tested (cases)	Test result
Shockable (sensitivity): Coarse VF Rapid VT	200 50	>90% >75%	205 80	Met Met
Nonshockable (specificity): Normal sinus rhythm Asystole Other nonshockable rhythms	300 100 100 30	>99% >95% >95%	171 180 385	Met Met Met
Intermediate: Fine VF Other VT	25 25	Report only Report only	27 42	66.67% shockable 76.19% nonshockable

^a. Kerber RE, et al, "Automatic External Defibrillators for Public Access Defibrillation: Recommendations for Specifying and Reporting Arrhythmia Analysis Algorithm Performance, Incorporating New Waveforms, and Enhancing Safety: A Statement for Health Professionals from the American Heart Association Task Force on Automatic External Defibrillation", Subcommittee on AED Safety and Efficacy. Circulation, 1997: Vol. 95: 1677-1682.

^b. Clause 201.7.9.3.103 "Essential Performance data of the Rhythm Recognition Detector" and clause 201.107 "Requirements for Rhythm Recognition Detector," International Electrotechnical Association, IEC 60601-2-4, Medical Electrical Equipment – Part 2-4: Particular Requirements for the Basic Safety and Essential Performance of Cardiac Defibrillators: 2010.

C

EMC and Radio Regulatory Compliance

C.1 EMC

The equipment meets the requirements of IEC 60601-1-2: 2014.

WARNING

- **Use of accessories, transducers and cables other than those specified or provided by the manufacturer of this device could result in increased electromagnetic emissions or decreased electromagnetic immunity of this device and result in improper operation.**
 - **Use of this device adjacent to or stacked with other device should be avoided because it could result in improper operation. If such use is necessary, this device and the other device should be observed to verify that they are operating normally.**
 - **Portable RF communications equipment (including peripherals such as antenna cables and external antennas) should be used no closer than 30 cm (12 inches) to any part of the this device, including cables specified by the manufacturer. Otherwise, degradation of the performance of this device could result.**
 - **Other devices may affect this equipment even though they meet the requirements of CISPR.**
 - **When the inputted signal is below the minimum amplitude provided in technical specifications, erroneous measurements could result.**
-
-

NOTE

- **The equipment needs special precautions regarding EMC and needs to be installed and put into service according to the EMC information provided below.**
 - **Portable and mobile RF communications equipment may affect this equipment.**
 - **This equipment is intended for use in professional healthcare facility environment, or in home healthcare environment such as restaurants, cafes, shops, stores, markets, schools, churches, libraries, outdoors (streets, sidewalks, parks), domiciles (residences, homes, nursing homes), train stations, bus stations, airports, hotels, hostels, pensions, museums, theatres. If it is used in special environment, such as magnetic resonance imaging environment, the equipment may be disrupted by the operation of nearby equipment.**
-

Guidance and Declaration - Electromagnetic Emissions		
The equipment is suitable for use in the electromagnetic environment specified below. The customer or the user of the equipment should assure that it is used in such an environment.		
Emission test	Compliance	Electromagnetic environment - guidance
RF emissions CISPR 11	Group 1	The equipment uses RF energy only for its internal function. Therefore, its RF emissions are very low and are not likely to cause any interference in nearby electronic equipment.
RF emissions CISPR 11	Class B	The equipment is suitable for use in all establishments, including domestic establishments and those directly connected to the public low-voltage power supply network that supplies buildings used for domestic purposes.

If the device is operated within the electromagnetic environment listed in Table **Guidance and Declaration - Electromagnetic Immunity**, the equipment will remain safe and provide the following essential performance: energy accuracy, CPR function, data stored.

Guidance and Declaration - Electromagnetic Immunity			
The equipment is suitable for use in the electromagnetic environment specified below. The customer or the user of the equipment should assure that it is used in such an environment.			
Immunity test	IEC 60601 test level	Compliance level	Electromagnetic environment - guidance
Electrostatic discharge (ESD) IEC 61000-4-2	±8 kV contact ±15 kV air	±8 kV contact ±15 kV air	Floors should be wood, concrete or ceramic tile. If floors are covered with synthetic material, the relative humidity should be at least 30%.
Power frequency (50/60 Hz) magnetic field IEC 61000-4-8	30 A/m	30 A/m	Power frequency magnetic fields should be at levels characteristic of a typical location in a typical commercial or hospital environment.

Guidance and Declaration - Electromagnetic Immunity			
The equipment is suitable for use in the electromagnetic environment specified below. The customer or the user of the equipment should assure that it is used in such an environment.			
Immunity test	IEC 60601 Test level	Compliance level	Electromagnetic environment - guidance
Conducted RF IEC 61000-4-6	3 Vrms 150k to 80 MHz	3 Vrms (V1)	Portable and mobile RF communications equipment should be used no closer to any part of the device, including cables, than the recommended separation distance calculated from the equation applicable to the frequency of the transmitter. Recommended separation distance: $d = \left[\frac{3.5}{V1} \right] \sqrt{P} \quad 150k \text{ to } 80 \text{ MHz}$ $d = \left[\frac{3.5}{E1} \right] \sqrt{P} \quad 80 \text{ MHz to } 800 \text{ MHz}$ $d = \left[\frac{7}{E1} \right] \sqrt{P} \quad 800 \text{ MHz to } 2.7 \text{ GHz}$
	6 Vrms in ISM bands and amateur radio bands ^a between 0.15 MHz and 80 MHz	6 Vrms (V2)	
Radiated RF EM fields IEC 61000-4-3	3V/m 80 MHz to 2.7 GHz	3 V/m (E1)	where P is the maximum output power rating of the transmitter in watts (W) according to the transmitter manufacturer and d is the recommended separation distance in meters (m) ^b . Field strengths from fixed RF transmitters, as determined by an electromagnetic site survey ^c , should be less than the compliance level in each frequency range ^d . Interference may occur in the vicinity of equipment marked with the following symbol: 
	10V/m 80 MHz to 2.7 GHz (IEC60601-2-4)	10 V/m	
	20V/m 80 MHz to 2.7 GHz (IEC60601-2-4)	20 V/m	
Proximity fields from RF wireless communication s equipment IEC61000-4-3	27 V/m 380 to 390 MHz	27 V/m	
	28 V/m 430 to 470 MHz, 800 to 960 MHz, 1700 to 1990 MHz, 2400 to 2570 MHz	28 V/m	
	9 V/m 704 to 787 MHz, 5100 to 5800 MHz	9 V/m	

Note 1: At 80 MHz and 800 MHz, the higher frequency range applies.

Note 2: These guidelines may not apply in all situations. Electromagnetic propagation is affected by absorption and reflection from structures, objects and people.

^a The ISM (industrial, scientific, and medical) bands between 150 kHz and 80 MHz are 6.765 MHz to 6.795 MHz; 13.553 MHz to 13.567 MHz; 26.957 MHz to 27.283 MHz; and 40.66 MHz to 40.70 MHz. The amateur radio bands between 0,15 MHz and 80 MHz are 1,8 MHz to 2,0 MHz, 3,5 MHz to 4,0 MHz, 5,3 MHz to 5,4 MHz, 7 MHz to 7,3 MHz, 10,1 MHz to 10,15 MHz, 14 MHz to 14,2 MHz, 18,07 MHz to 18,17 MHz, 21,0 MHz to 21,4 MHz, 24,89 MHz to 24,99 MHz, 28,0 MHz to 29,7 MHz and 50,0 MHz to 54,0 MHz.

^b Compliance level in the ISM frequency bands between 150 kHz to 80 MHz and in the frequency range 80 MHz to 2.7 GHz are intended to decrease the likelihood that portable/ mobile communication equipment could cause interference if it is inadvertently brought into patient areas. For this reason, an additional factor of 10/3 is used in calculating the recommended separation distance for transmitters in these frequency ranges.

^c Field strengths from fixed transmitters, such as base stations for radio (cellular/cordless) telephones and land mobile radios, amateur radio, AM and FM radio broadcast and TV broadcast cannot be predicted theoretically with accuracy. To assess the electromagnetic environment due to fixed RF transmitters, an electromagnetic site survey should be considered. If the measured field strength in the location in which the device is used exceeds the applicable RF compliance level above, the device should be observed to verify normal operation. If abnormal performance is observed, additional measures may be necessary, such as reorienting or relocating the device.

^d Over the frequency ranges 150 kHz to 80 MHz, field strengths should be less than 3V/m.

Recommended Separation Distances between Portable and Mobile RF, Communications Equipment and This Equipment

The equipment is intended for use in an electromagnetic environment in which radiated RF disturbance are controlled. The customer or the user of the equipment can help prevent electromagnetic interference by maintaining a minimum distance between portable and mobile RF communications equipment (transmitters) and the equipment as recommended below, according to the maximum output power of the communication equipment.

Rated Maximum Output power of Transmitter Watts (W)	Separation Distance According to Frequency of Transmitter (m)		
	150 kHz to 80 MHz $d = \left[\frac{3.5}{V1} \right] \sqrt{P}$	80 MHz to 800 MHz $d = \left[\frac{3.5}{E1} \right] \sqrt{P}$	800 MHz to 2.7 GHz $d = \left[\frac{7}{E1} \right] \sqrt{P}$
0.01	0.12	0.12	0.23
0.1	0.38	0.38	0.73
1	1.20	1.20	2.30
10	3.80	3.80	7.30
100	12.00	12.00	23.00

For transmitters at a maximum output power not listed above, the recommended separation distanced in meters (m) can be determined using the equation applicable to the frequency of the transmitter, where P is the maximum output power rating of the transmitter in watts (W) according to the transmitter manufacturer.

Note 1: At 80 MHz and 800 MHz, the higher frequency range applies.

Note 2: These guidelines may not apply in all situations. Electromagnetic propagation is affected by absorption and reflection from structures, objects and people.

C.2 Radio Regulatory Compliance

Wi-Fi

Operating frequency	IEEE 802.11 b/g/n (at 2.4G): 2.412 GHz to 2.472 GHz IEEE 802.11 a/n (at 5G): 5.18 GHz to 5.24 GHz, 5.745 GHz to 5.825 GHz
Modulation mode	DSSS and OFDM
Output Power	≤20 dBm

Cellular

Operating frequency	LTE-FDD B1: 1920 MHz to 1980 MHz, 2110 MHz to 2170 MHz LTE-FDD B3: 1710 MHz to 1785 MHz, 1805 MHz to 1880 MHz LTE-FDD B7: 2500 MHz to 2570 MHz, 2620 MHz to 2690 MHz LTE-FDD B8: 880 MHz to 915 MHz, 925 MHz to 960 MHz LTE-FDD B20: 832 MHz to 862 MHz, 791 MHz to 821 MHz LTE-FDD B28A: 703 MHz to 733 MHz, 758 MHz to 788 MHz LTE-TDD B38: 2570 MHz to 2620 MHz LTE-TDD B40: 2300 MHz to 2400 MHz
Standard/Modulation mode	3GPP E-UTRA Release 11: LTE-FDD/LTE-TDD
Output Power	≤25 dBm



The device complies with the essential requirements and other relevant provisions of Directive 2014/53/EU.

WARNING

- **Keep a distance of at least 20 cm away from the equipment when the wireless function is in use.**
-
-

D Default Settings

The following tables list all configurable setup options for the equipment with all functions. Your equipment may not have all of them.

D.1 General Setup

Menu Item	Description	Options/Range	Default
System Date	Year	2007 to 2099	/
	Month	01 to 12	
	Day	01 to 31	
System Time	Hour	0 to 23	
	Minute	0 to 59	
	Second	0 to 59	
Language	Sets the language for voice prompts.	At most three languages	/
Voice Recording	Selects whether the recording function is enabled.	On, Off	Off
Voice Volume	Sets the volume level for voice prompts. <ul style="list-style-type: none"> • Auto: the equipment automatically adjusts the volume according to the ambient noise. • Low level if noise < 30 db • High level if noise > 80 db • Not specified if 30 db < noise < 80 db 	Auto, High, Low	Auto
Brightness	Sets the screen brightness. <p>Auto: the equipment automatically adjusts the screen brightness according to the ambient light.</p>	Auto, Outdoor Mode, Indoor mode	Auto
Patient Type	Sets the patient category.	Adult, Pediatric	Adult

D.2 AED Setup

Menu Item	Description	Options/Range	Default
Shock Series	Sets the number of shocks. If it is set to greater than one, the equipment resumes analyzing the patient's rhythm after the shock is delivered to determine if the shock was successful. Prompts for shock counter are provided to guide you delivering additional shocks.	1, 2, 3	1
Energy 1 (Adult)	Sets the defibrillation energy level for the first shock on the adult patient.	100, 150, 170, 200, 300, 360J	200 J
Energy 2 (Adult)	Energy 1 ≤ configurable value ≤ Energy 3	Energy 1 to 360J	300 J
Energy 3 (Adult)	Energy 2 ≤ configurable value	Energy 2 to 360J	360 J
Energy 1 (Pediatric)	Sets the defibrillation energy level for the first shock on the children.	10, 15, 20, 30, 50, 70, 100J	50 J
Energy 2 (Pediatric)	Energy 1 ≤ configurable value ≤ Energy 3	Energy 1 to 100 J	70 J
Energy 3 (Pediatric)	Energy 2 ≤ configurable value	Energy 2 to 100 J	100 J
Initial CPR	Selects whether the equipment enters the CPR status directly after turned on.	On, Off	Off
ECG Display	Selects whether the ECG waveform is displayed.	On, Off	Off
Auto Release Time	Sets the time the equipment automatically removes the stored energy internally.	30s, 60s, 90s, 120s	30s

D.3 CPR Setup

Menu Item	Description	Options/Range	Default
CPR Mode (Adult)	Sets the rate of compression and ventilation.	30:2, 15:2, Hands-Only	30:2
CPR Mode (Pediatric)			15:2
CPR Voice Prompts	Selects whether voice prompts are provided when using a CPR metronome.	On, Off	On

D.4 Test Setup

Menu Item	Description	Options/Range	Default
Auto Test Time	Sets the start time for auto test.	00:00, 01:00, 02:00, 03:00, 04:00, 05:00	03:00
Auto Test Period	Sets the interval for auto test startup.	Daily, Weekly	Daily
Transmission Interval	Sets the interval for sending auto test report to the AED ALERT system.	Daily, Weekly	Weekly

D.5 WLAN Setup

If the equipment is configured with the Wi-Fi module, the related setup options are shown as below.

Menu Item	Description	Options/Range	Default
Device Management System Site	Input the IP address or domain name of AED ALERT system	/	aed-alert.mindray.com
Device Management System Port	Input the port of AED ALERT system	0 to 65535	16903
Network Name	Input the network name of Wi-Fi hotspot.	0 to 32 characters	/
Address Type	Manual: Address Type, IP Address, Subnet Mask are required. DHCP: the equipment automatically gets IP address.	Manual, DHCP	DHCP
IP Address		4 segments, and editable range 0 to 255 for each	/
Subnet Mask			
Gateway			
Security	/	WPA/WPA2 PSK, WPA/WPA2 EAP	WPA/WPA2 PSK
Password	/	0 to 64 characters	/
WLAN Band	/	5G, 2.4G	2.4G

If the equipment configured with the cellular module, the related setup options are shown as below.

Menu Item	Description	Options/Range	Default
Device Management System Site	Input the IP address or domain name of AED ALERT system	/	aed-alert.mindray.com
Device Management System Port	Input the port of AED ALERT system	0 to 65535	16903

D.6 AED ALERT Related Setup

If the equipment is connected to the AED ALERT system through the wireless network, the related setup options are shown as below.

Menu Item	Description	Options/Range	Default
Device Enabled Reminder	Sends messages to the designated person on the AED ALERT system when the equipment is turned on, turned off or out of the specified location.	On, Off	On
Auto Upload Rescue Data	Uploads the rescue events (not including ECG waveforms) automatically to the AED ALERT system after a rescue.	On, Off	On

E Voice Prompts

The following table lists voice prompts that may occur during a rescue.

Condition	Voice Prompt	Description
Open the lid	Powered on. Stay calm. Follow the instructions.	The lid is opened.
	Device error. Recommended to replace the Device. Stay calm. Follow the instructions.	The equipment malfunctions, use one standby equipment or start CPR immediately.
After turning on the equipment	Adult mode	The Adult/Child mode switch is pressed to Adult, or the electrode pads connected to the equipment are detected for the adult patient.
	Child mode. if the patient is an Adult, adjust the Adult/Child mode switch to Adult mode.	The Adult/Child mode switch is pressed to Child.
	Child mode	The Adult/Child mode switch is pressed to Child, or the electrode pads connected to the equipment are detected for the children.
Place the electrode pads	Remove clothing from patient's chest. Apply pads as shown on Pads.	Prompts to remove the patient's clothing and place the electrode pads.
	Remove clothing from patient's chest. Plug in pads connector.	
	Remove pads package from lid of AED. Tear open package. Apply pads as shown on Pads.	
	Apply pads as shown on Pads.	
	Apply pads as shown on Pads.	
	Abnormal Pads connection.	Pads connection failure, start CPR immediately.
The equipment analyzes the patient's heart rhythm.	Do not touch the patient. Analyzing heart rhythm.	Repeats until analysis of the patient's heart rhythm is completed. This prompt will be interrupted if the equipment is ready to shock.
	No shock advised.	Notifies non-shockable rhythm has been detected.
	Motion detected. Do not touch or move the patient.	The equipment detects ECG noise artifacts, stop moving or touching the patient.
	Noise detected. Make sure pads are firmly attached.	The equipment detects ECG noise artifacts, better pads contact on the patient's skin is required.
	Pads off. Analysis interrupted.	Pads connection failure, the equipment automatically stops the heart rhythm analysis. Reconnect the electrode pads.

Condition	Voice Prompt	Description
The equipment delivers a shock.	Shock advised. Everyone clear.	Notifies a shockable rhythm has been detected.
	Shock will be delivered in: 3, 2, 1	Prompts the equipment is fully charged and is preparing to deliver a defibrillation shock.
	Shock delivered.	Prompts the shock is delivered.
	Press flashing shock button	Prompts the equipment is fully charged and ready to deliver the defibrillation shock.
	Shock canceled. Shock button was not pressed.	The Shock button is not pressed within 30s and the equipment cancels the shock.
	Device error, charge failed.	The equipment is unable to start charging because of a fault condition. The equipment resumes the rhythm analysis after a charging failure. After three consecutive charging failures, the equipment automatically enters the CPR status.
	Device error, shock failed.	The equipment is unable to deliver a shock because of a fault condition. Or, it is not suitable to deliver a shock to the patient. The equipment disarms itself and resumes the rhythm analysis after a discharging failure. After three consecutive discharging failures, the equipment automatically enters the CPR status.
	Shock canceled. Press pads firmly to patient's bare skin.	
	Shock canceled. Pads must not be touching each other.	
	Rhythm change, shock canceled	The equipment detects a rhythm change and cancels the shock
Perform CPR	Start CPR immediately.	Prompts to prepare to provide compressions and breaths CPR.
	Give chest compressions immediately.	Prompts to prepare to provide compressions-only CPR.
	Continue to compress without rescue breaths.	
	Place one hand on center of chest, the other hand should be on top of first hand. Interlock the fingers. Continue to push down hard.	
	Place one hand on center of chest. Keep arms straight. Continue to push down hard.	
	Keep arms straight. Continue to push down hard.	
	Interlock the fingers. Continue to push down hard.	
	100 compressions remaining.	
	50 compressions remaining.	
	20 compressions remaining.	

Condition	Voice Prompt	Description
Perform CPR	Push down hard.	Prompts to use more effort for compressions.
	Continue to push down hard.	
	Stop CPR.	Prompts to stop CPR.
	Continue with compressions.	Prompts to continue CPR.
	Give two rescue breaths.	Prompts to give breath to the patient.
	One	
	Two	
	Follow the metronome to give 200 compressions approximately.	Prompts the CPR metronome pacing the speed of compressions.
	Follow the metronome to give 30 compressions and 2 rescue breaths.	Prompts to prepare to provide compressions and breaths CPR.
	Follow the metronome to give 15 compressions and 2 rescue breaths.	
Use a CPR sensor for CPR	Incomplete recoil	Prompts to use more effort and release all pressure when moving hands up.
	Compress faster	Prompts to adjust the compression rate.
	Compress slower	
	Compress deeper	Prompts to adjust the compression rate.
	Compress shallower	

This page intentionally left blank.

F Symbols and Abbreviations

F.1 Units

μA	microampere
μV	microvolt
A	ampere
Ah	ampere hour
bpm	beat per minute
bps	bit per second
$^{\circ}\text{C}$	centigrade
cm	centimeter
dB	decibel
$^{\circ}\text{F}$	fahrenheit
h	hour
Hz	hertz
in	inch
J	Joule
kg	kilogram
kPa	kilopascal
L	litre
m	meter
min	minute
mm	millimeter
ms	millisecond
mV	millivolt
mW	milliwatt
rpm	breaths per minute
s	second
V	volt
Ω	ohm

F.2 Symbols

–	negative, minus
%	percent
/	per; divide; or
+	plus
=	equal to
<	less than
>	greater than
≤	less than or equal to
≥	greater than or equal to
±	plus or minus
×	multiply
©	copyright

F.3 Abbreviations and Acronyms

AAMI	Association for Advancement of Medical Instrumentation
Adu	adult
AED	Semi-automated external defibrillation
AHA	American Heart Association
ANSI	American National Standard Institute
aVF	left foot augmented lead
aVL	left arm augmented lead
aVR	right arm augmented lead
CE	Conformité Européenne
CISPR	International Special Committee on Radio Interference
CPR	Cardiopulmonary resuscitation
DC	direct current
Defib	defibrillation
ECG	electrocardiograph
EMC	electromagnetic compatibility
EMI	electromagnetic interference
ESU	electrosurgical unit
FDA	Food and Drug Administration
HR	heart rate
ID	identification
IEC	International Electrotechnical Commission
IP	internet protocol

Iso	isoflurane
LA	left arm
LCD	liquid crystal display
LED	light emitting diode
LL	left leg
MRI	magnetic resonance imaging
Neo	neonate
O ₂	oxygen
Ped	pediatric
PNC	pacer not captured
PNP	pacer not paced
PVC	premature ventricular complex
RA	right arm
Rec	record, recording
RL	right leg
Sync	synchronization
USB	universal serial bus

This page intentionally left blank.

G Inspection Record

Current Date (Month/Year): ____ / ____
Place a "√" in the corresponding box

Daily Checklist					
Inspection Date	Status indicator flashes	Inspected by	Inspection Date	Status indicator flashes	Inspected by
1.	in green <input type="checkbox"/> in red <input type="checkbox"/>		17.	in green <input type="checkbox"/> in red <input type="checkbox"/>	
2.	in green <input type="checkbox"/> in red <input type="checkbox"/>		18.	in green <input type="checkbox"/> in red <input type="checkbox"/>	
3.	in green <input type="checkbox"/> in red <input type="checkbox"/>		19.	in green <input type="checkbox"/> in red <input type="checkbox"/>	
4.	in green <input type="checkbox"/> in red <input type="checkbox"/>		20.	in green <input type="checkbox"/> in red <input type="checkbox"/>	
5.	in green <input type="checkbox"/> in red <input type="checkbox"/>		21.	in green <input type="checkbox"/> in red <input type="checkbox"/>	
6.	in green <input type="checkbox"/> in red <input type="checkbox"/>		22.	in green <input type="checkbox"/> in red <input type="checkbox"/>	
7.	in green <input type="checkbox"/> in red <input type="checkbox"/>		23.	in green <input type="checkbox"/> in red <input type="checkbox"/>	
8.	in green <input type="checkbox"/> in red <input type="checkbox"/>		24.	in green <input type="checkbox"/> in red <input type="checkbox"/>	
9.	in green <input type="checkbox"/> in red <input type="checkbox"/>		25.	in green <input type="checkbox"/> in red <input type="checkbox"/>	
10.	in green <input type="checkbox"/> in red <input type="checkbox"/>		26.	in green <input type="checkbox"/> in red <input type="checkbox"/>	
11.	in green <input type="checkbox"/> in red <input type="checkbox"/>		27.	in green <input type="checkbox"/> in red <input type="checkbox"/>	
12.	in green <input type="checkbox"/> in red <input type="checkbox"/>		28.	in green <input type="checkbox"/> in red <input type="checkbox"/>	
13.	in green <input type="checkbox"/> in red <input type="checkbox"/>		29.	in green <input type="checkbox"/> in red <input type="checkbox"/>	
14.	in green <input type="checkbox"/> in red <input type="checkbox"/>		30.	in green <input type="checkbox"/> in red <input type="checkbox"/>	
15.	in green <input type="checkbox"/> in red <input type="checkbox"/>		31.	in green <input type="checkbox"/> in red <input type="checkbox"/>	
Monthly Checklist					
Expiration date of electrode pads:					

This page intentionally left blank.

H Device Tracking

In order to provide high quality product and perform better service, we are going to track our product. Please contact us with the device tracking information when you have received your defibrillator/monitor:

Please fill the information in the next page, cut the table and fax it to +86 755 26582934. You can also email your information to service@mindray.com.

This page intentionally left blank.

Device Tracking Information

User Information

Customer Name

Department name

Address

City

State

Zip/Post Code

Country

Contact Person

Tel No.

Fax No.

Email Address

Device Information

Product name

Serial number

Model

Installation Date

Declaration of Conformity

Declaration of Conformity V1.0



Declaration of Conformity

Manufacturer: Shenzhen Mindray Bio-Medical Electronics Co., Ltd.
Mindray Building, Keji 12th Road South, Hi-tech Industrial
Park, Nanshan, Shenzhen, 518057, P. R. China

EC-Representative: Shanghai International Holding Corp. GmbH (Europe)
Eiffestraße 80
20537 Hamburg, Germany

Product: Automatic External Defibrillator (Including Accessories)

Model: BeneHeart C1 Fully Automatic、BeneHeart C1A Fully
Automatic、BeneHeart C2 Fully Automatic、BeneHeart C2A
Fully Automatic、BeneHeart S1 Fully Automatic、BeneHeart
S1A Fully Automatic、BeneHeart S2 Fully Automatic、
BeneHeart S2A Fully Automatic

We herewith declare under our sole responsibility that the above mentioned products meet the provisions of the Council Directive 2014/53/EU concerning radio equipment. All supporting documentation is retained under the premises of the manufacturer.

Standards Applied:

<input checked="" type="checkbox"/> EN 60601-1:2006/A1:2013	<input checked="" type="checkbox"/> IEC 60601-1-2: 2014
<input checked="" type="checkbox"/> EN 62311:2008	<input checked="" type="checkbox"/> ETSI EN 301 489-1 V2. 1.1
<input checked="" type="checkbox"/> ETSI EN 301 489-3 V2.1.1	<input checked="" type="checkbox"/> ETSI EN 301 489-17 V3.1.1
<input checked="" type="checkbox"/> ETSI EN 301 489-52 V1.1.0	<input checked="" type="checkbox"/> ETSI EN 301 893 V2.1.1
<input checked="" type="checkbox"/> ETSI EN 301 908-1 V11.1.1	<input checked="" type="checkbox"/> ETSI EN 301 908-13 V11.1.2
<input checked="" type="checkbox"/> ETSI EN 300 328 V2.1.1	<input checked="" type="checkbox"/> ETSI EN 300 440 V2.2.1

Start of CE-Marking: 2019-8-2

Place, Date of Issue: Shenzhen, 2019.8.2

Signature:

Name of Authorized Signatory: Mr. Wang Xinbing

Position Held in Company: Manager, Technical Regulation

Declaration of Conformity V1.0



Declaration of Conformity

Manufacturer: Shenzhen Mindray Bio-Medical Electronics Co., Ltd.
Mindray Building, Keji 12th Road South, Hi-tech Industrial
Park, Nanshan, Shenzhen, 518057, P. R. China

EC-Representative: Shanghai International Holding Corp. GmbH (Europe)
Eiffestraße 80
20537 Hamburg, Germany

Product: Automatic External Defibrillator (Including Accessories)

Model: BeneHeart C1、 BeneHeart C1A、 BeneHeart C2、 BeneHeart
C2A、 BeneHeart S1、 BeneHeart S1A、 BeneHeart S2、
BeneHeart S2A

We herewith declare under our sole responsibility that the above mentioned products meet the provisions of the Council Directive 2014/53/EU concerning radio equipment. All supporting documentation is retained under the premises of the manufacturer.

Standards Applied:

<input checked="" type="checkbox"/> EN 60601-1:2006/A1:2013	<input checked="" type="checkbox"/> IEC 60601-1-2: 2014
<input checked="" type="checkbox"/> EN 62311:2008	<input checked="" type="checkbox"/> ETSI EN 301 489-1 V2. 1.1
<input checked="" type="checkbox"/> ETSI EN 301 489-3 V2.1.1	<input checked="" type="checkbox"/> ETSI EN 301 489-17 V3.1.1
<input checked="" type="checkbox"/> ETSI EN 301 489-52 V1.1.0	<input checked="" type="checkbox"/> ETSI EN 301 893 V2.1.1
<input checked="" type="checkbox"/> ETSI EN 301 908-1 V11.1.1	<input checked="" type="checkbox"/> ETSI EN 301 908-13 V11.1.2
<input checked="" type="checkbox"/> ETSI EN 300 328 V2.1.1	<input checked="" type="checkbox"/> ETSI EN 300 440 V2.2.1

Start of CE-Marking: 2019-8-2

Place, Date of Issue: Shenzhen, 2019.8.2

Signature:

Name of Authorized Signatory: Mr. Wang Xinbing

Position Held in Company: Manager, Technical Regulation

